

AERO

Ventilation control unit

Window systems

Door systems

Comfort systems

Table of contents

1	ABOUT THIS DOCUMENTATION	4
1.1	Read the instructions	4
1.2	Producer	4
1.3	Notice on gender	4
1.4	Target group	4
1.5	Other relevant information	4
2	SAFETY	5
2.1	Designated use	5
2.2	Requirements for the target group	5
2.3	Safety notes	5
3	PRODUCT SPECIFICATIONS	6
3.1	Operating element	6
3.2	Operation	7
3.2.1	Master functionality	7
3.2.2	Slave functionality	8
3.2.3	Functions	8
3.2.4	Temperature and humidity sensor	8
3.2.5	CO2 sensor	8
3.2.6	Ventilation levels	9
3.2.7	Automatic mode	9
3.2.8	Child-proof lock	9
3.2.9	Night ventilation	9
3.2.10	Filter replacement indicator	9
3.2.11	Air quality indicator	9
3.3	Technical specifications	10
3.4	Accessories	10
4	OPERATION	11
4.1	Pairing the ventilation control unit with ventilation units	11
4.2	Adjusting the ventilation level	11
4.3	Activating and deactivating automatic mode	12
4.4	Activating and deactivating the child- proof lock	12
4.5	Activating and deactivating night ventilation	12
4.6	Setting the LED brightness	13
5	TROUBLESHOOTING	14
5.1	Error messages	14
5.2	Faults on the unit	14
6	CERTIFICATES	15
6.1	EU declaration of conformity	15

1 About this documentation

1.1 Read the instructions

These instructions are an important document and part of the product. Only the defined procedures are safe. Persons can be injured or material damage could occur if these instructions are not observed.

Read and observe the instructions completely before using the product.

Retain these instructions, keep them available and pass them on to subsequent users.

1.2 Producer

SIEGENIA-AUBI KG
Industriestraße 1 – 3
57234 Wilnsdorf
Germany

You can find the addresses of our worldwide locations here: siegenia.com/company/locations

Entry in Commercial Register:

- Registry court: Siegen district court
- Register number: HRA 3741

1.3 Notice on gender

The linguistic form used serves for easier readability and always means all genders as long as nothing else is explicitly mentioned.

1.4 Target group

This information is aimed at all persons who carry out the following activities:

- operation and maintenance of SIEGENIA products
- operation and maintenance of window elements or door elements that are equipped with SIEGENIA products

1.5 Other relevant information

- Operating and service instructions for AEROMAT VT A / Z

link.si/td/fens012/1023



- Operating and service instructions AEROPLUS WRG

link.si/td/wans010/1123



- Operating and service instructions for AEROMAT VT WRG / WRG plus

link.si/td/fens014/1023

2 Safety

2.1 Designated use

- The ventilation control unit is an external, wired control unit for SIEGENIA ventilation systems with SI-BUS.
- The ventilation control unit can be paired with a single ventilation unit (if the control panel for the ventilation unit is out of reach, for example) or can be used for the synchronised control of up to 9 ventilation units simultaneously.
- The ventilation control unit must be kept away from heat sources, drafts and direct sunlight and must not be surrounded by furniture.

2.2 Requirements for the target group

The following persons may only operate the product if they have understood the dangers involved in handling the product or if they are supervised during operation:

- children
- persons with diminished physical, sensory or mental capabilities
- persons with a lack of experience and knowledge

2.3 Safety notes

Risk of explosion due to electrical sparks

When operating the product in environments with an explosive atmosphere, electrical sparks may cause an explosion. Explosive atmospheres are created, for example, by flammable liquids, steam, gas or dust.

- Do not use the product in environments with an explosive atmosphere.

Risk of injury from using unsuitable components

Components, accessories and spare parts which do not comply with SIEGENIA requirements can impair the safety of the product and lead to accidents.

- Use original parts or components that comply with the SIEGENIA requirements. If in doubt, contact SIEGENIA for confirmation.

3 Product specifications

3.1 Operating element

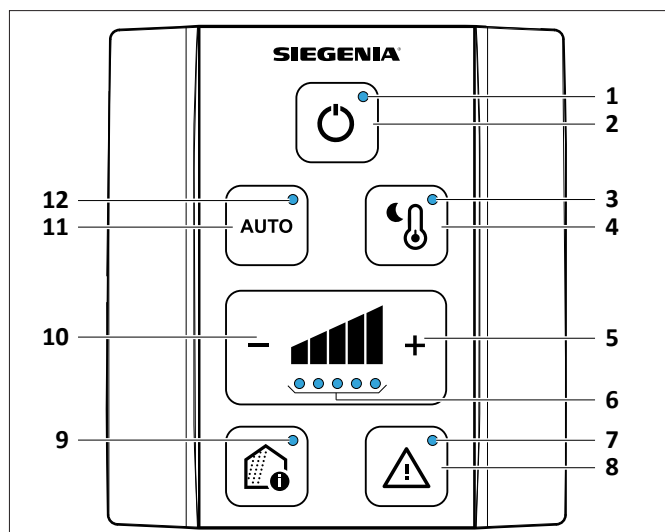

Item	Name	Purpose
1	Status LED	<ul style="list-style-type: none"> Lights up white when the coupled ventilation units are switched on.
2	ON/OFF button	<ul style="list-style-type: none"> Switches the coupled ventilation units on and off.
3	Night ventilation LED	<ul style="list-style-type: none"> Lights up white when night ventilation is active.
4	Night ventilation button	<ul style="list-style-type: none"> Activates and deactivates night ventilation. If automatic mode is active, automatic mode is deactivated when night ventilation is activated.
5	Increase ventilation level button	<ul style="list-style-type: none"> Increases the ventilation level in steps from 1 to 5.
6	Ventilation level LEDs	<ul style="list-style-type: none"> Light up white depending on which ventilation level is active.
7	Warning LED	<ul style="list-style-type: none"> Lights up or flashes yellow or red when there is an error. Lights up yellow when the filter needs replacing.
8	Warning button	<ul style="list-style-type: none"> Acknowledges the errors messages shown. Press and hold to acknowledge the filter replacement indicator.
9	Air quality LED	<ul style="list-style-type: none"> Lights up green, yellow or red to indicate the air quality level.
10	Reduce ventilation level button	<ul style="list-style-type: none"> Reduces the ventilation level in steps from 5 to 1.
11	AUTO button	<ul style="list-style-type: none"> Activates and deactivates automatic mode. If night ventilation is active, night ventilation is deactivated when automatic mode is activated.
12	AUTO LED	<ul style="list-style-type: none"> Lights up white when automatic mode is active.

3.2 Operation

Example: ventilation control unit with 3 AEROPLUS WRG

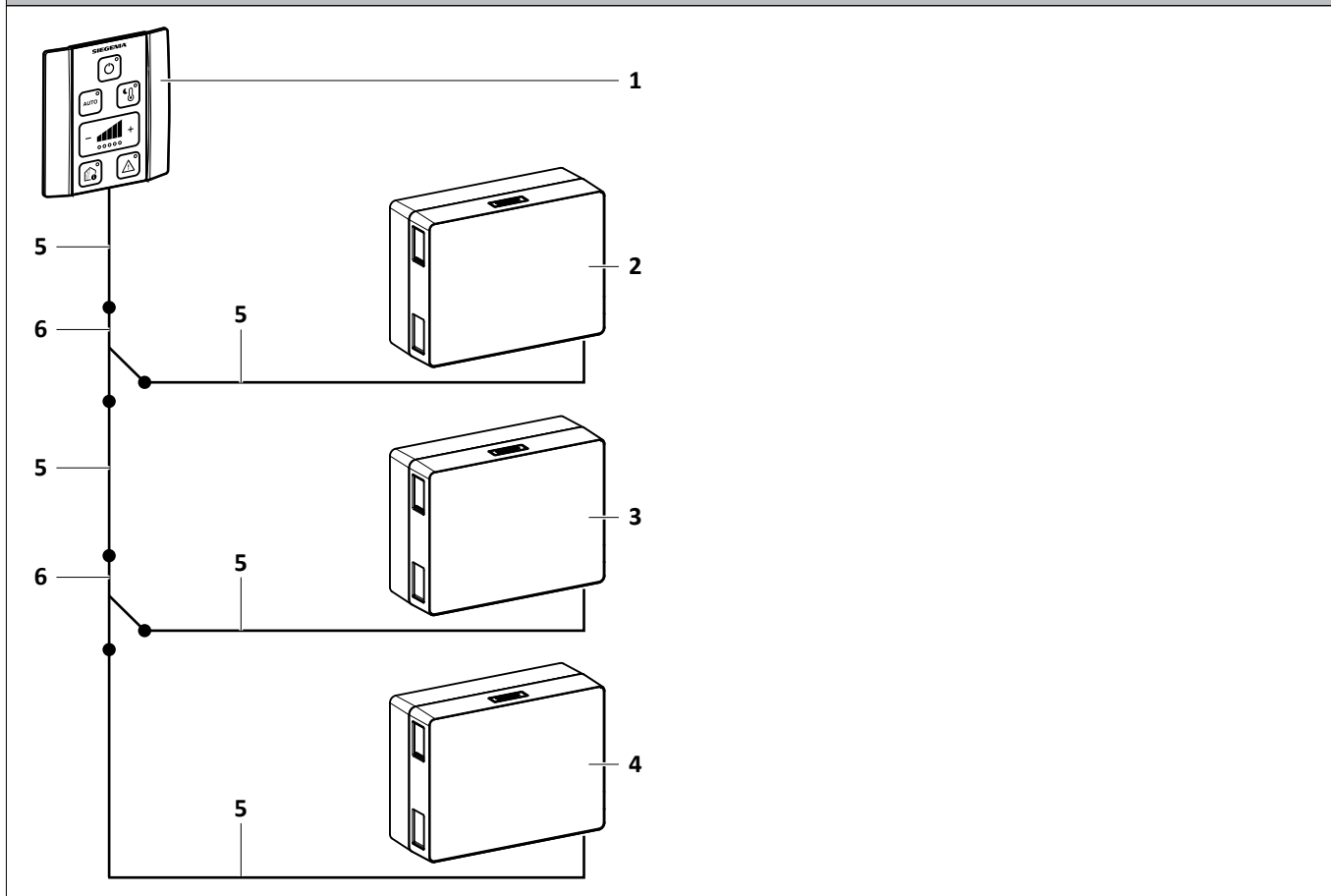

Item	Name
1	Ventilation control unit
2	Master
3	Slave 1
4	Slave 2
5	Connection cable (with extension cable if required)
6	Y-adapter cable

The ventilation control unit can be coupled with between 1 and 9 ventilation units via the SI-BUS. If there is more than one ventilation unit in the bus system, the connected ventilation units follow a master-slave hierarchy. The master is always the ventilation unit from whose menu the coupling was carried out. All other ventilation units are slaves. It is possible to couple different types of ventilation units.

3.2.1 Master functionality

- The master is directly controlled by the ventilation control unit and transmits the commands to the slaves.
- Local settings can be adjusted on the ventilation unit or via the SIEGENIA Comfort app.
- Local settings on the master are also transmitted to the slaves and displayed on the ventilation control unit.
- In the SIEGENIA Comfort app, the slaves and the ventilation control unit are displayed in the detail view of the master.
- The master transmits the following data to the ventilation control unit:
 - Air quality
 - Error messages and status alerts
 - Upcoming filter replacement

AERO – Operating and care instructions

Ventilation control unit

3.2.2 Slave functionality

- The slaves follow the commands transmitted by the master.
- Local settings for the ventilation unit can be adjusted on the slaves.
- Local settings apply only to the ventilation unit in question and only until the master transmits a new command.

3.2.3 Functions

Functional element	Device type	
	Ventilation control unit	Ventilation control unit sensors
Temperature and humidity sensor	-	●
CO ₂ sensor	-	●
Different blower levels	●	●
Automatic mode	●	●
Night ventilation	●	●
Filter replacement indicator	●	●
Air quality indicator	●	●

Symbol	Explanation
●	Standard version
○	Optional or alternative version
-	not available

3.2.4 Temperature and humidity sensor

- The temperature and humidity sensor measures the temperature and humidity.
- In the SIEGENIA Comfort app, the measured values are displayed in the detail view of the master.

3.2.5 CO₂ sensor

- The CO₂ sensor measures the CO₂ content in the indoor air.
- In the SIEGENIA Comfort app, the CO₂ content is displayed in the detail view of the master using a traffic light system and a numerical value.

3.2.6 Ventilation levels

- The air throughput can be set at 5 levels on the ventilation control unit.
- The ventilation control unit displays the ventilation levels using 5 LEDs.
- Following a power failure, the ventilation control unit switches to the last ventilation level used.

3.2.7 Automatic mode

- Automatic mode controls the ventilation levels automatically depending on the environmental conditions.
- If the ventilation control unit is equipped with sensors, the values from the ventilation control unit are used to control the ventilation unit.
- If the ventilation control unit does not have sensors, the ventilation levels are controlled based on the values from the master. The required ventilation level is determined by the temperature, humidity, CO₂ value or air quality, depending on how the Master is configured.
- The ventilation control unit indicates automatic mode using an LED.

3.2.8 Child-proof lock

- The child-proof lock disables the buttons on the unit.

3.2.9 Night ventilation

- Night ventilation controls the ventilation levels automatically based on the indoor and outdoor temperatures.
- During night ventilation, ventilation is carried out without heat recovery to allow the room to cool down.
- The ventilation control unit indicates night ventilation using an LED.
- The connected ventilation units must be configured separately for night ventilation.

3.2.10 Filter replacement indicator

- The "warning message" LED lights up yellow when the filter needs replacing.
- Pressing the "warning message" button acknowledges the filter replacement indicator.

3.2.11 Air quality indicator

- The ventilation control unit uses an LED to indicate the air quality, which lights up green, yellow or red.

AERO – Operating and care instructions

Ventilation control unit

3.3 Technical specifications

	Ventilation control unit	Ventilation control unit sensors
Power consumption	0.6 W	0.8 W
SI-BUS nominal voltage	24 V DC (+5 %, -10 %)	24 V DC (+5 %, -10 %)
Protection class	IP20	IP20
Ambient temperature	-20 – +70 °C	-20 – +70 °C
Ambient air humidity	max. 85%, non-condensing	max. 85%, non-condensing
Permissible operating temperature of sensors	–	0 – 50 °C

3.4 Accessories

Name	Pc.	Material number
Connection cable (L = 1 m)	1	L7360030-000010
Connection cable (L = 2 m)	1	L7360040-000010
Connection cable (L = 5 m)	1	L7360050-000010
Y-adapter cable (L = 0.1 m)	1	GAPC0060-000010
Extension cable (L = 2 m)	1	L7360070-000010

4 Operation

4.1 Pairing the ventilation control unit with ventilation units

Prerequisite

- All units that are to be paired are connected to the SI-BUS.

1. Use the ventilation unit that is to become the master to pair the units. See the operating and service instructions provided with the ventilation unit.

→ All units that are connected are automatically integrated into the system one after the other.

→ The ventilation unit in question will beep to confirm that pairing has been successful.

4.2 Adjusting the ventilation level

1. Switch the paired ventilation units on by pressing the "ON/OFF" button.

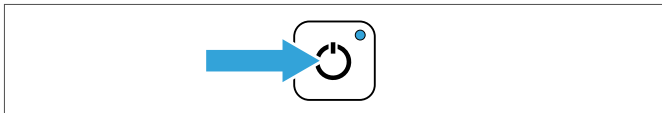

2. Increase or reduce the ventilation level by pressing the "ventilation level" button.

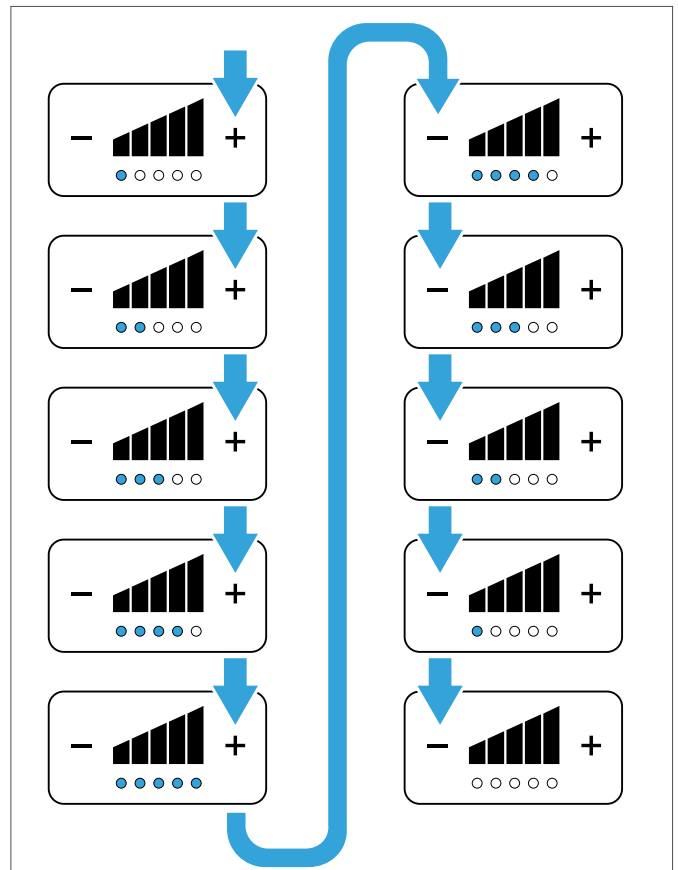

4.3 Activating and deactivating automatic mode

1. Switch the paired ventilation units on by pressing the "ON/OFF" button.

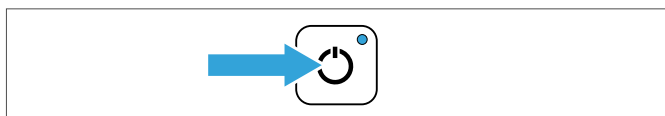

2. Activate automatic mode by pressing the "AUTO" button.

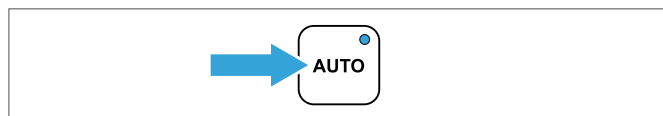

→ If night ventilation was active, night ventilation is deactivated.

3. To deactivate automatic mode, press the "AUTO" button again.

4.4 Activating and deactivating the child-proof lock

1. Switch the unit on by pressing the "ON/OFF" button.

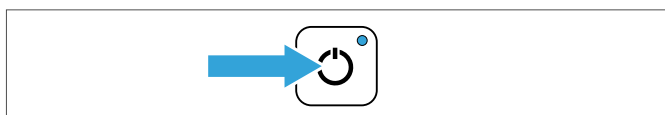

3. Press the "AUTO" button 3 times in quick succession.

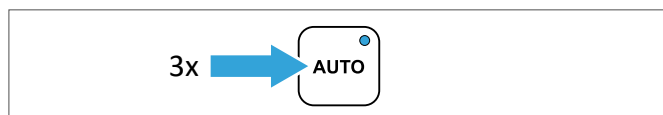

2. Press and hold the "night ventilation" button.

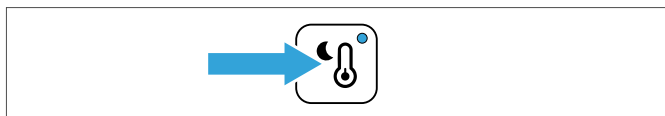

→ The child-proof lock is activated.

4. To deactivate the child-proof lock, press the same combination of buttons again.

4.5 Activating and deactivating night ventilation

Prerequisite

- The paired ventilation units are configured for night ventilation.

1. Switch the paired ventilation units on by pressing the "ON/OFF" button.

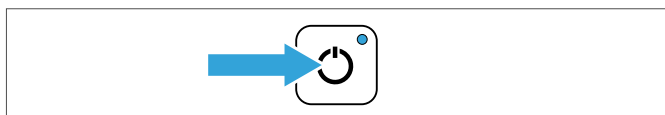

2. Activate night ventilation by pressing the "night ventilation" button on the ventilation control unit.

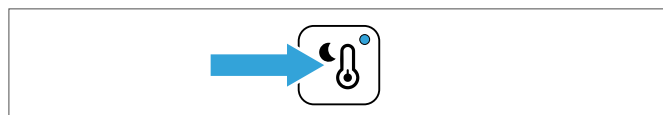

→ If automatic mode was active, automatic mode is deactivated.

3. To deactivate night ventilation, press the "night ventilation" button again.

4.6 Setting the LED brightness

1. Switch the unit on by pressing the "ON/OFF" button.

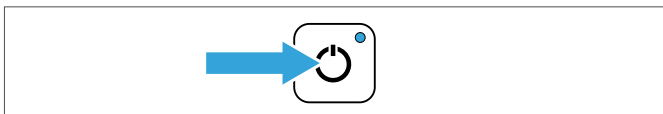

2. Press and hold the "minus" button.

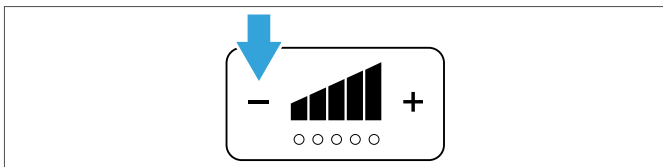

3. Press the "plus" button repeatedly until the desired brightness has been set.

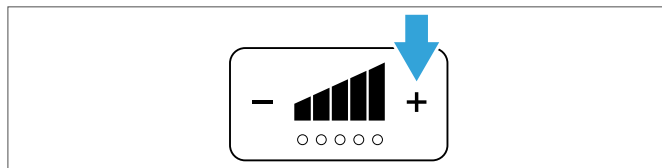

5 Troubleshooting

5.1 Error messages

1. If this table does not describe the error, contact the producer: link.si/td/service001/0324



LED	Possible cause	Solution
	Ventilation control unit not paired	Connect the ventilation control to the SI BUS system via the master menu
	Simple fault on the ventilation unit	See the operating and service instructions provided with the ventilation unit in question (see page 4) Contact your service partner if necessary
	Medium fault on the ventilation unit	
	Severe fault on the ventilation unit	

5.2 Faults on the unit

1. If this table does not describe the error, contact the producer: link.si/td/service001/0324



Problem	Possible cause	Solution
The unit does not respond when a button is pressed	No power supply	Check the power supply to the master
	Incorrect/defective wiring to the master or defective cable	Contact your service partner

6 Certificates

6.1 EU declaration of conformity

We, the producer, hereby declare that our product complies with the following directives.

Producer	Product	
SIEGENIA-AUBI KG Industriestraße 1 – 3 57234 Wilnsdorf	Device type:	Type designation:
	Central control unit for ventilation units	Ventilation control unit

Directives		Harmonised standards
EMC Directive	2014/30/EU	EN IEC 55014-1:2021 EN IEC 61000-6-3:2021 EN IEC 55014-2:2021 EN IEC 61000-6-1:2019 EN IEC 61000-3-2:2019 + A1:2021 EN 61000-3-3:2013 + A1:2019 + A2:2021
Low Voltage Directive	2014/35/EU	EN 60335-1:2012 EN 62233:2008
RoHS Directive	2011/65/EU	EN IEC 63000:2018

Underlying test reports: EMC Testhaus GmbH & Co KG – Test report 14/598

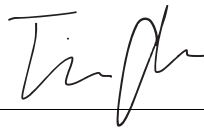

Wilnsdorf, 2024-04-11 Tim Opfer
(Group development leader)

www.siegenia.com



SIEGENIA®
brings spaces to life